

Universal Quick-Mount Bracket (25 to 60 mm)

VERSION: 1.3

Product Code: BRKT-A022

PRODUCT PHOTOGRAPH:

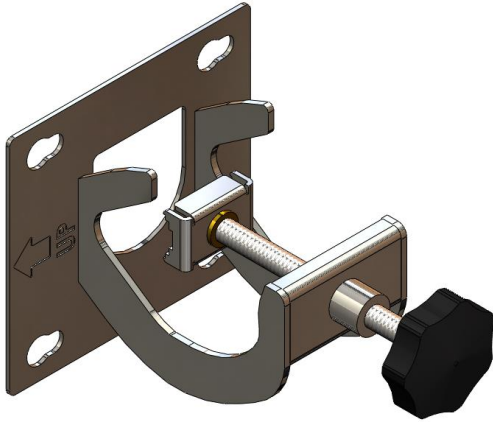

SPECIFICATIONS:

Mechanical:	
Dimensions	240 mm x 120 mm x 130 mm
Pole diameter	25 mm – 60 mm (1" to 2.25")
Materials	Steel
Total mass	550 g
Environmental: designed to meet the following specifications	
Wind survival	120 km/h with LPDA-A0076 mounted
Temperature	-30 °C to +70 °C
Relative humidity	100 %
Salt fog	Yes
Vibration	MIL-STD-810F vehicle
Shock	20 G

MOUNTING PHOTOS:

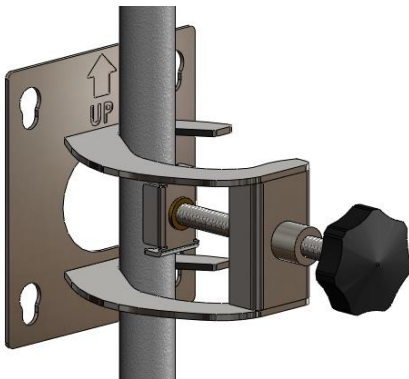

Showing mounting on LPDA-A0076

PRODUCT DESCRIPTION:

The BRKT-A022 is a quick-mounting bracket for attaching an antenna to a mast. It can be installed and removed by the action of a single clamping screw. It is intended to replace the traditional U-bolt solution, which has many loose parts, and is not practical for quick mounting.

Designed for the LPDA-A0076, the bracket incorporates a hole pattern for bolting permanently to the antenna. The antenna can then be fitted quickly to a mast or pole, without tools.

PRODUCT FEATURES:

- Quick fitting to pole
- Wide range of pole sizes accepted
- No tools required
- No loose parts to fall off
- One person operation

PRODUCT APPLICATIONS:

- Quick mast-mounting of antennas